

NEREO NEW

Art.-Nr.

395 881
395 882
395 883

1450
1115
516
mm

1/8

v0

21-2024

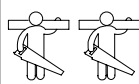

60 min

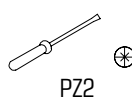

PZ2

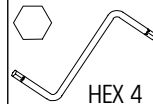

HEX 4

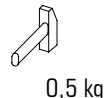

0,5 kg

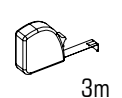

3m

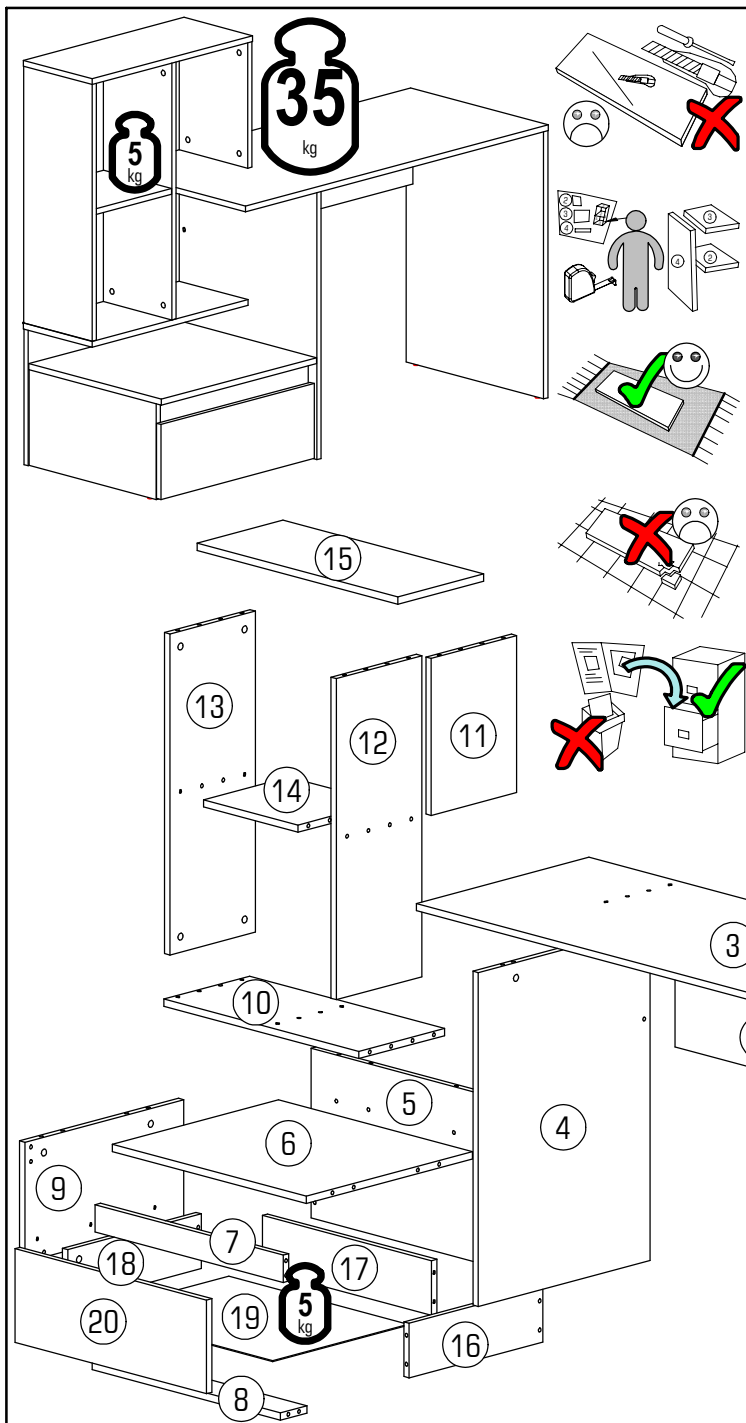

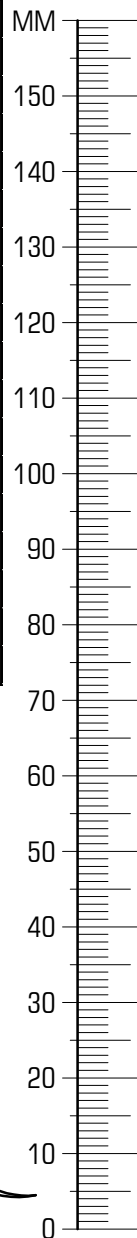

ID	ID	Dimensions	Quantity	Ratio
21281	②	833*240*16	1x	1/1
21282	③	1134*516*16	1x	1/1
21283	④	734*515*16	1x	1/1
21284	⑤	583*373*16	1x	1/1
21285	⑥	581*497*16	1x	1/1
21286	⑦	564*60*16	1x	1/1
21287	⑧	564*80*16	1x	1/1
21288	⑨	264*476*16	1x	1/1
21289	⑩	584*257*16	1x	1/1
21290	⑪	345*256*16	1x	1/1
21291	⑫	706*256*16	1x	1/1
21292	⑬	706*256*16	1x	1/1
21293	⑭	283*254*16	1x	1/1
21294	⑮	601*257*16	1x	1/1
20354	⑯	400*120*16	1x	1/1
21295	⑰	507*120*16	1x	1/1
20352	⑱	400*120*16	1x	1/1
21296	⑲	406*537*3	1x	1/1
21297	⑳	574*206*16	1x	1/1
21298	㉑	734*515*16	1x	1/1

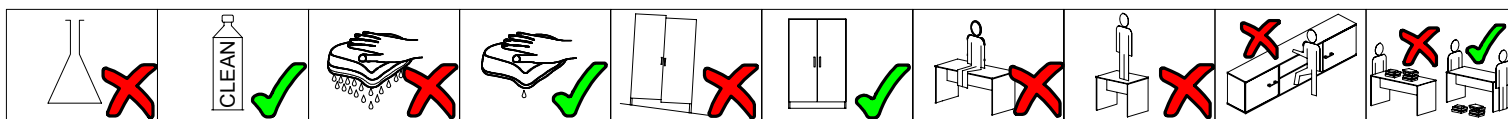

A	10x	B	42x	C	11x	D	38x	E	34x	F	6x	G	16x		
H	8x	J	3x	K	6x	L	2x	M	2x	N	1x	P	1x	R	2x

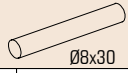
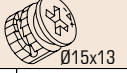
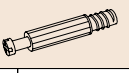
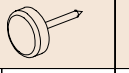

2/8 NEREO NEW

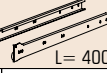
						
B 22x	D 12x	E 16x	F 4x	H 2x	K 6x	N 1x

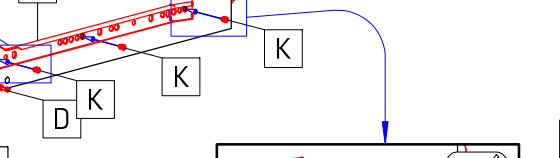
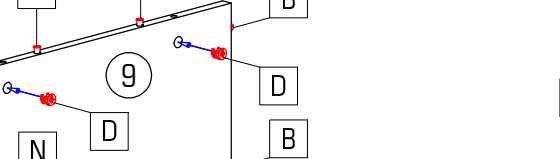
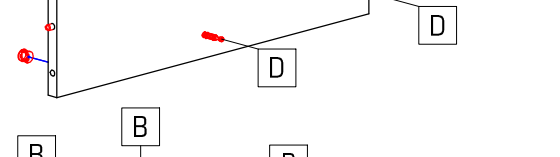
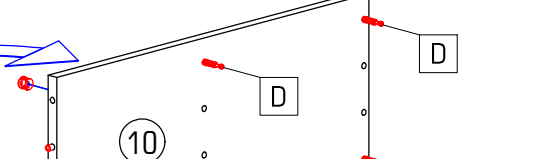
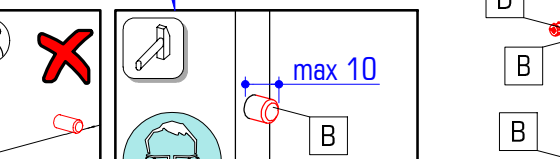
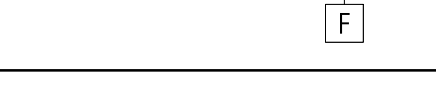
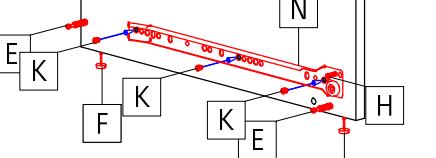
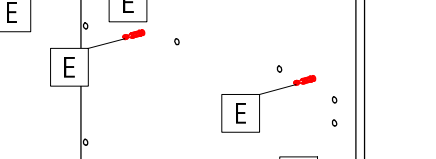
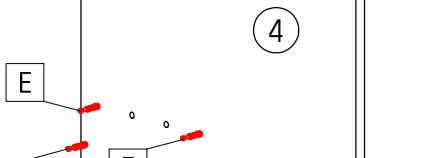
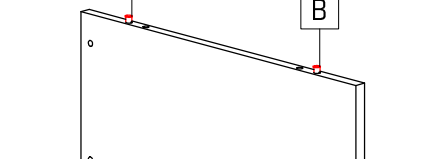
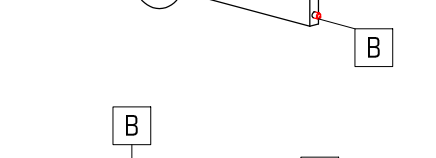
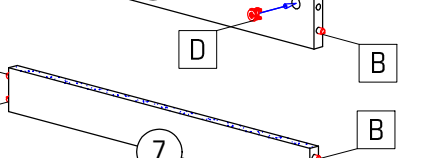
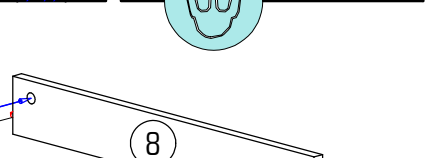
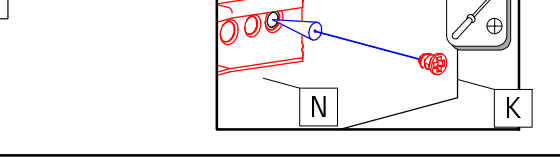
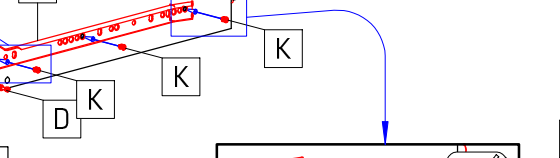
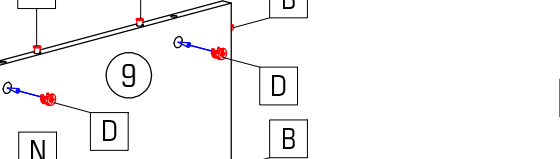
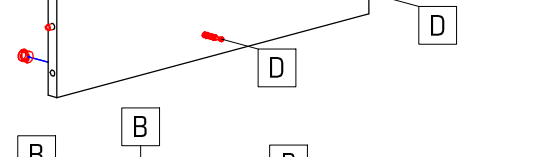
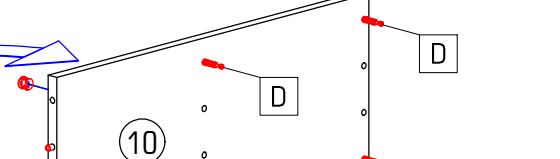
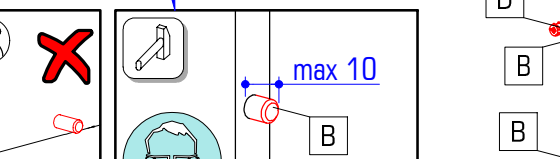
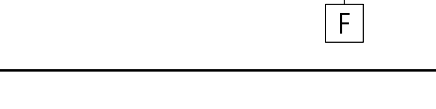
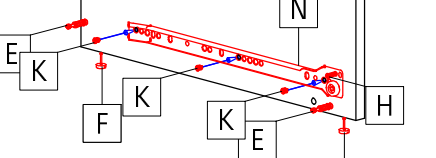
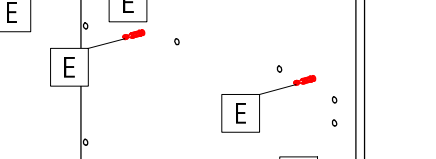
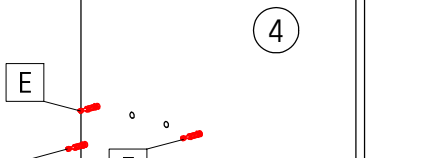
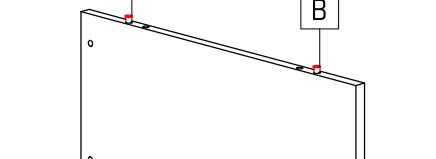
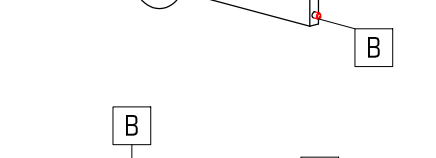
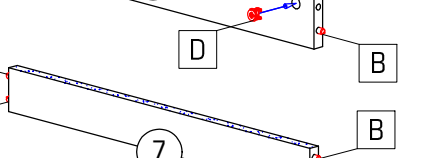
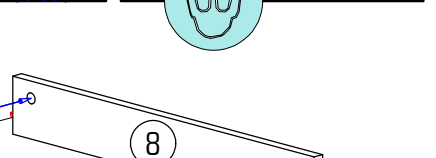
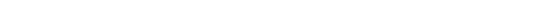
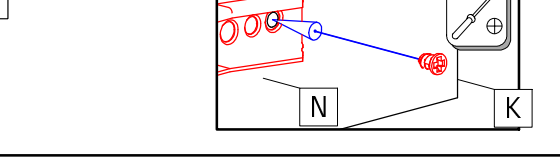
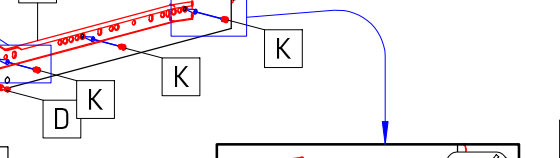
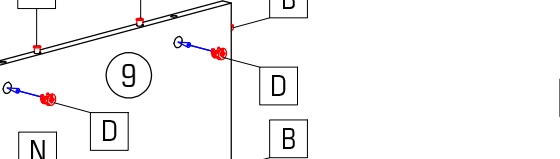
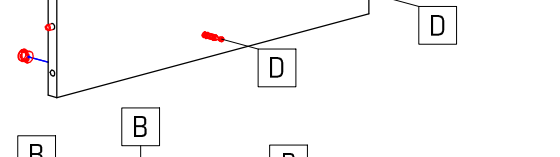
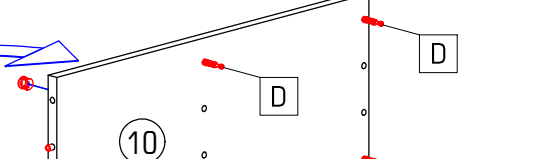
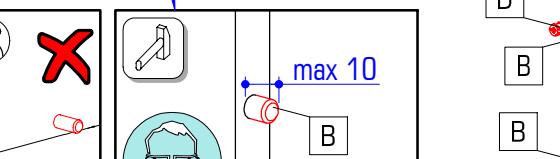
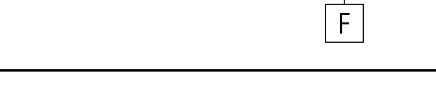
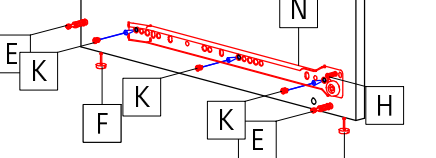
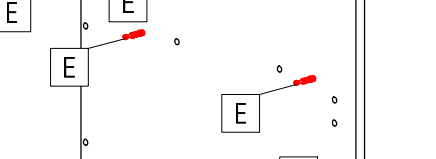
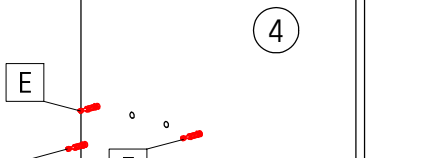
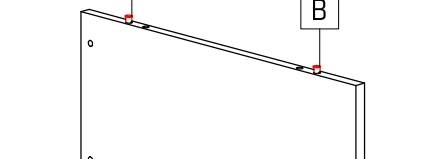
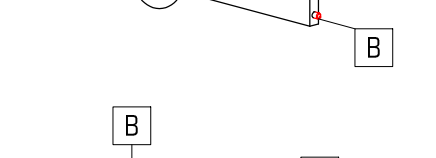
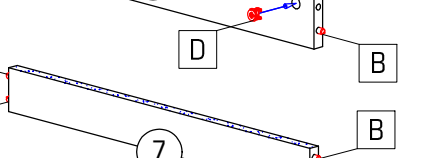
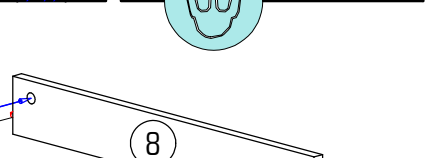
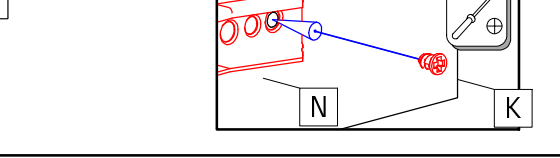
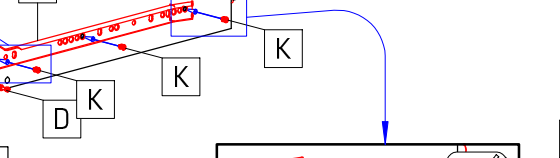
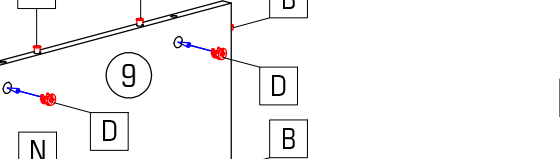
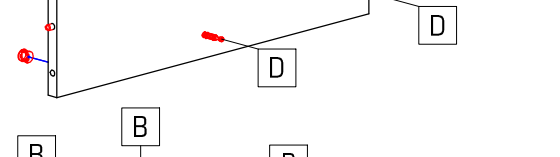
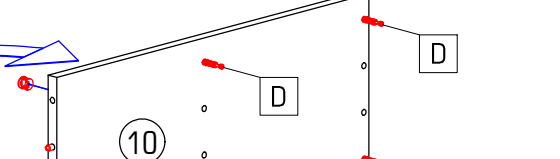
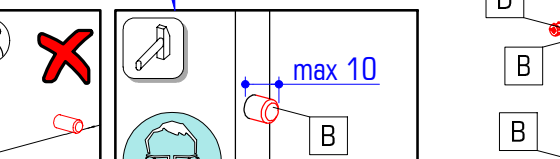
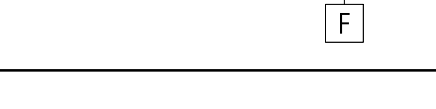
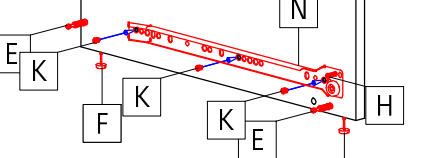
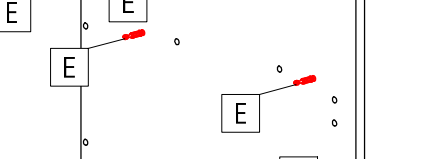
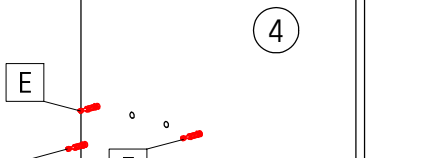
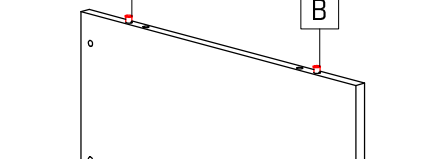
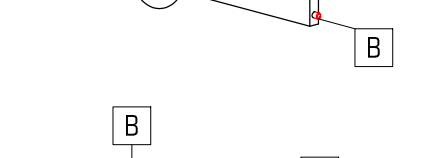
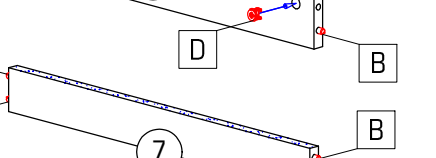
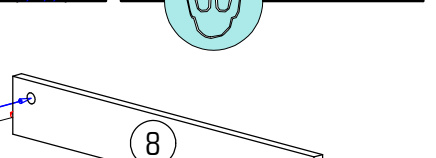
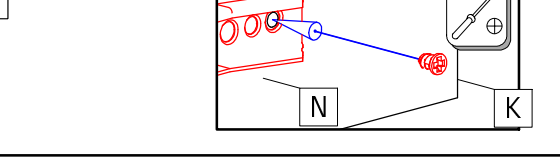
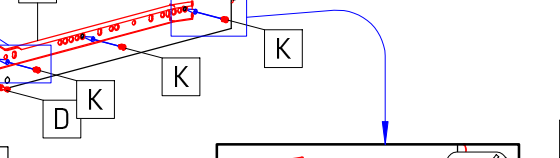
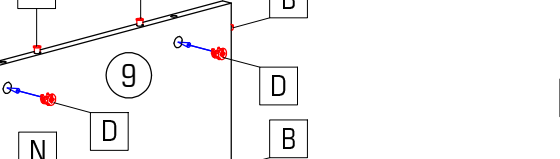
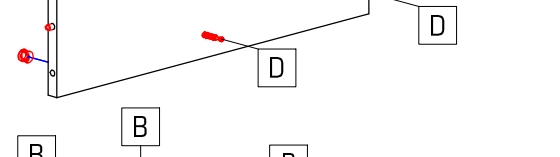
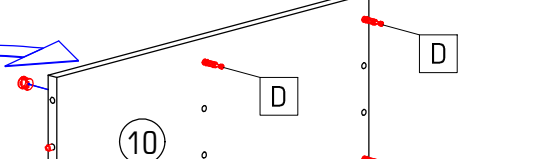
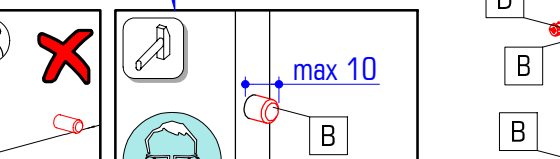
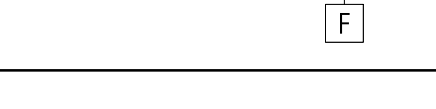
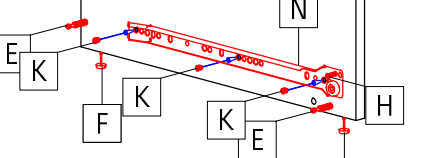
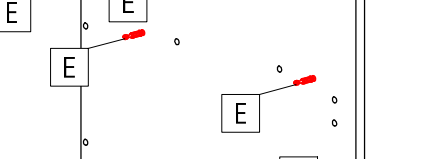
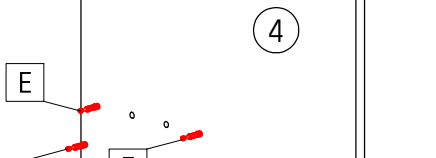
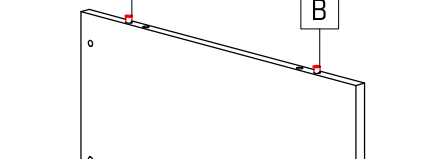
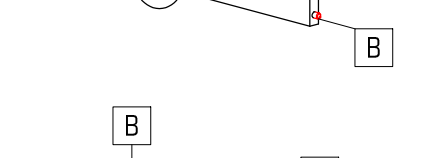
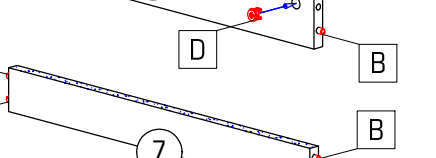
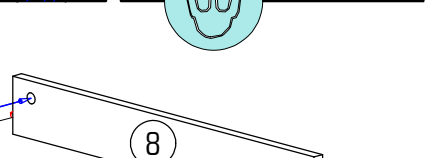
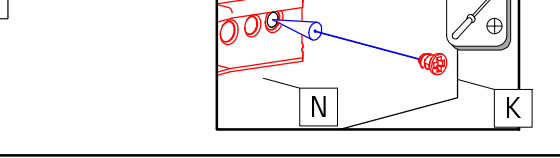
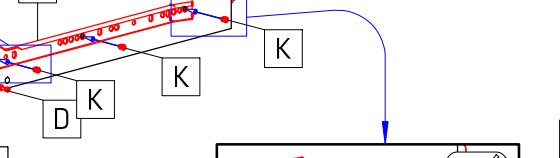
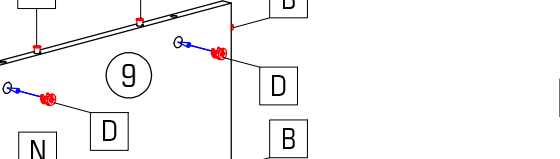
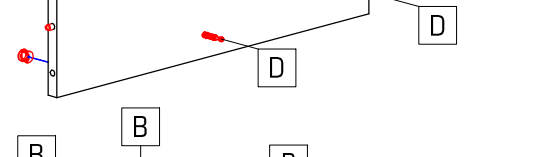
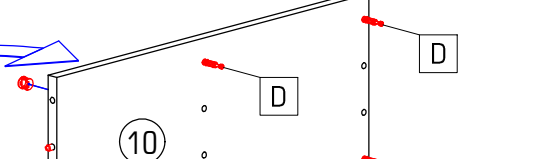
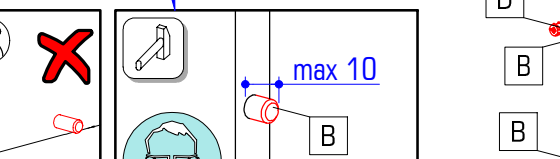
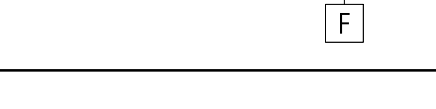
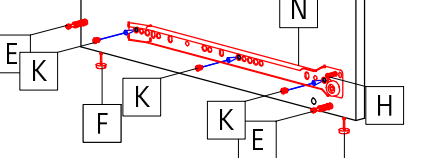
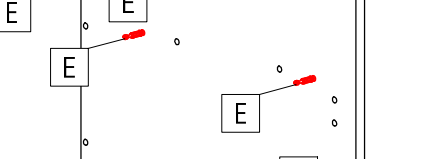
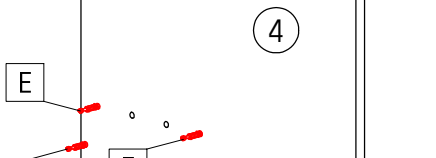
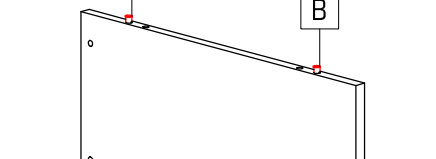
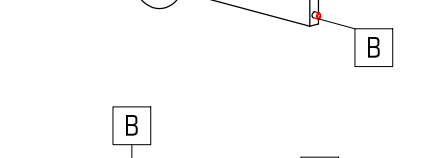
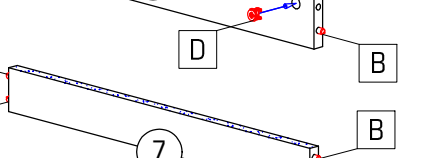
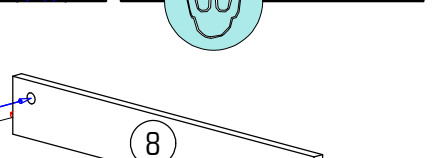
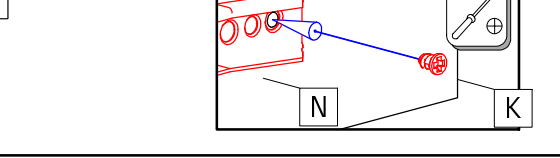
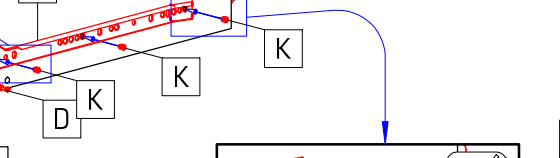
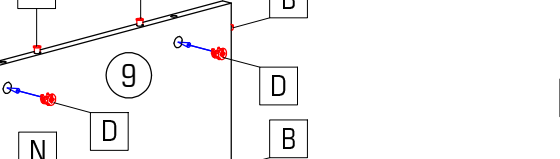
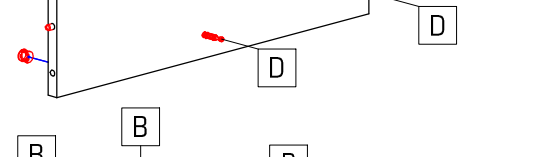
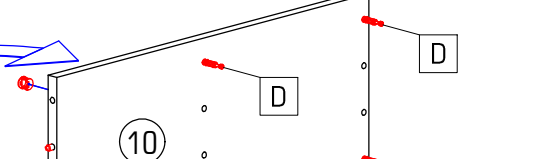
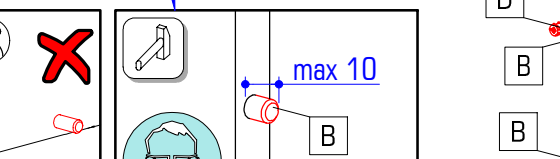
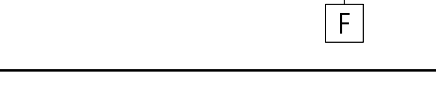
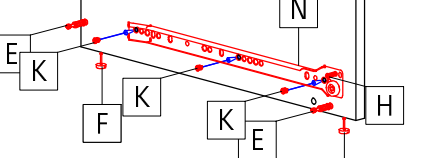
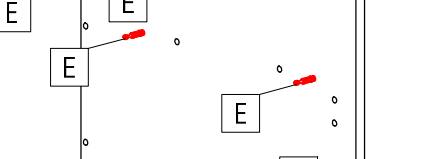
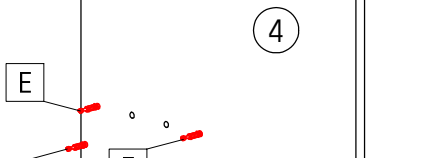
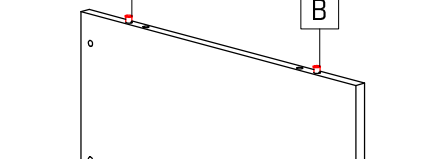
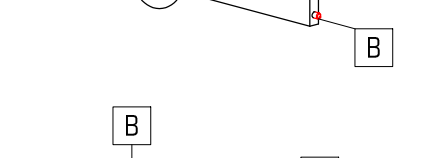
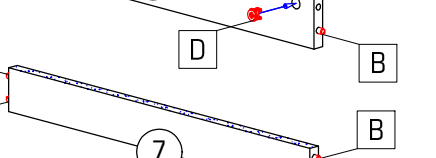
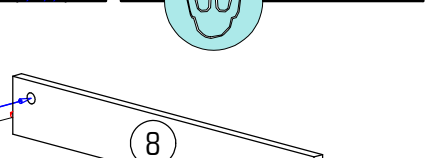
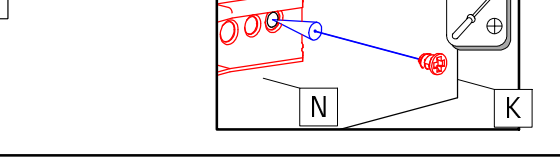
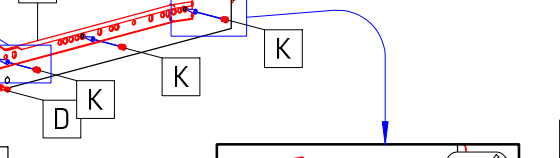
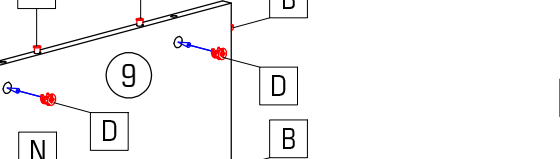
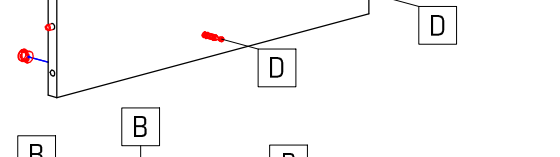
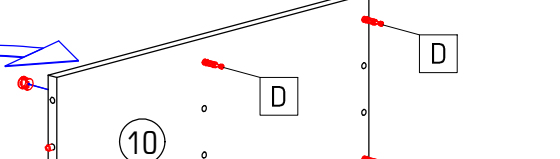
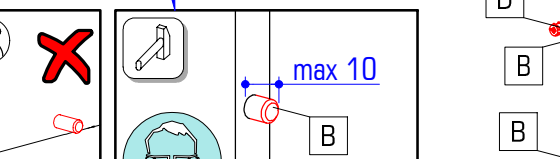
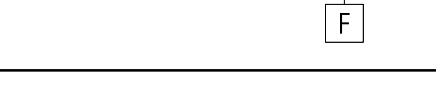
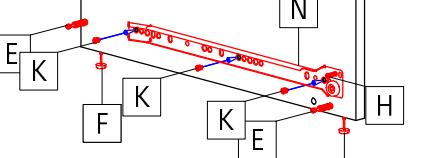
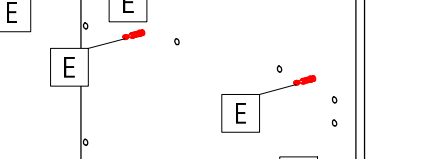
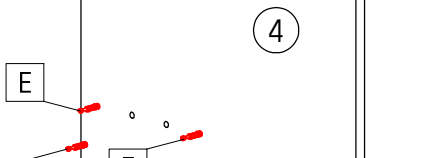
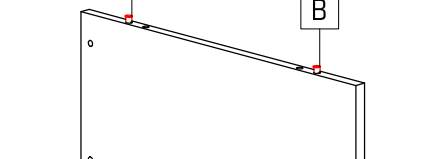
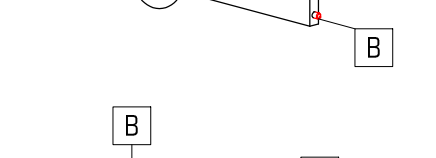
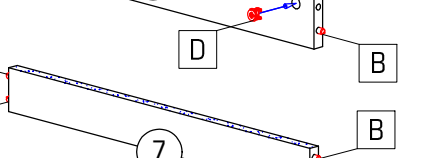
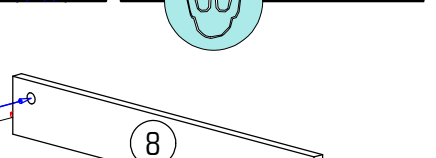
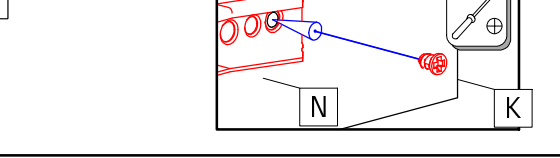
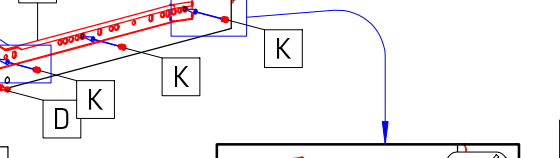
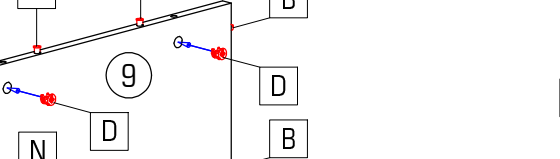
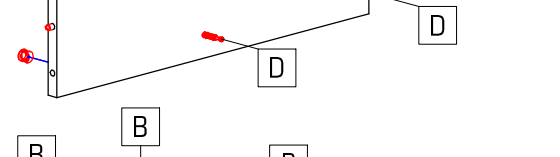
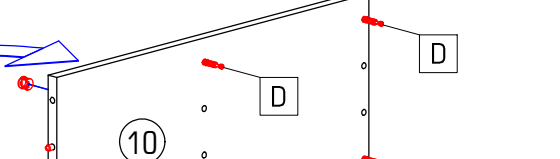
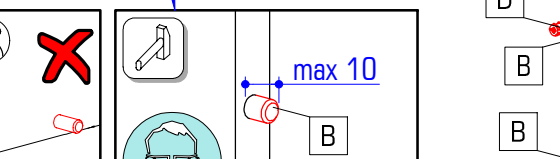
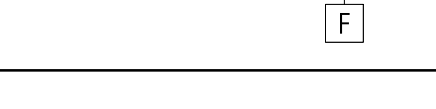
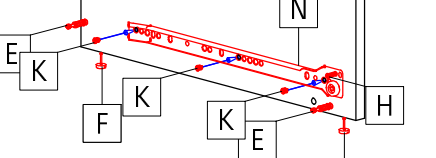
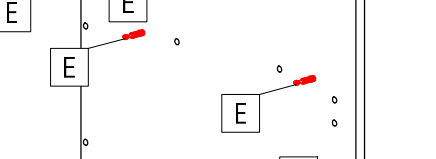
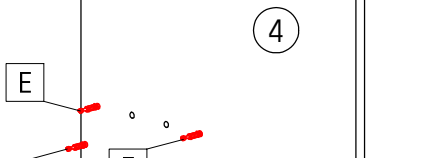
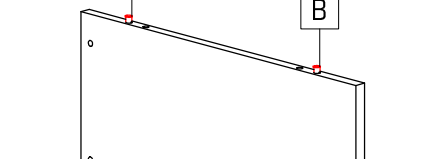
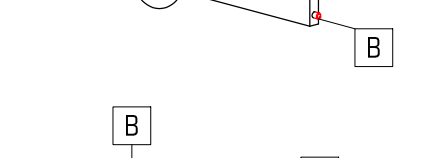
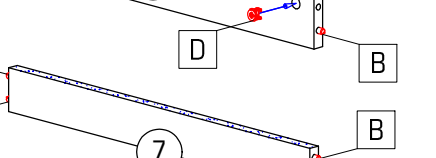
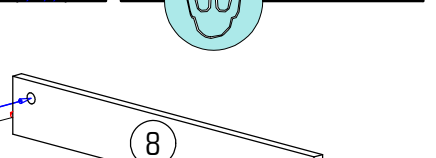
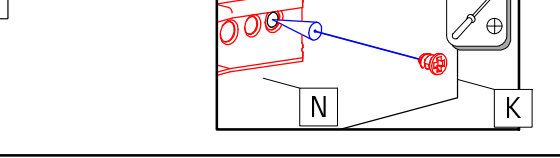
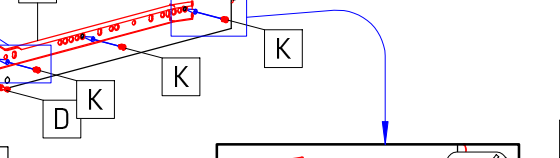
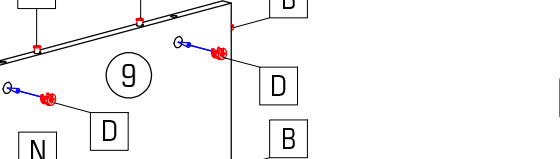
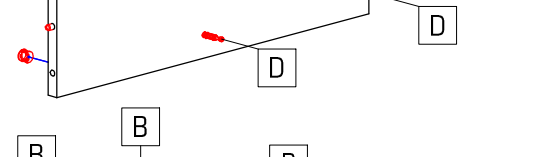
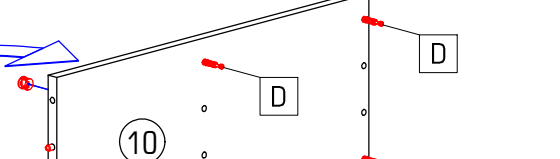
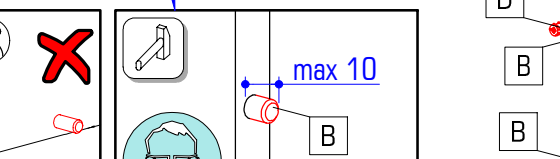
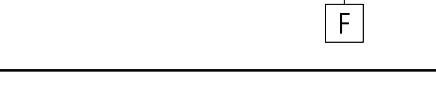
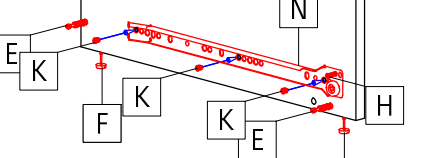
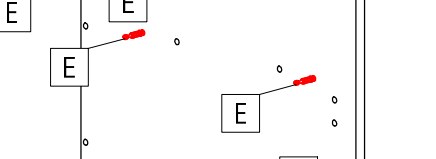
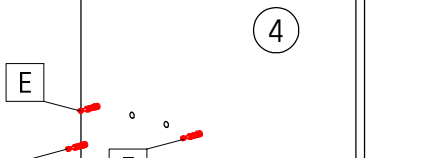
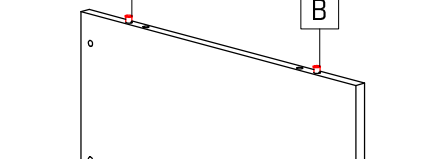
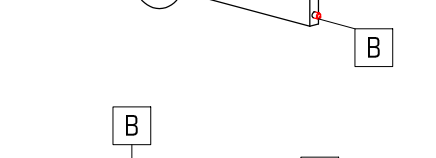
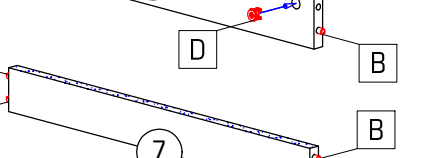
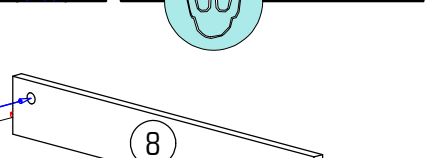
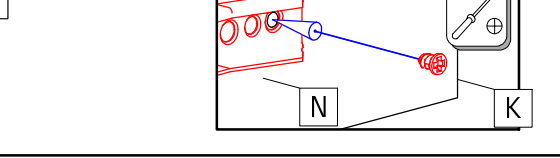
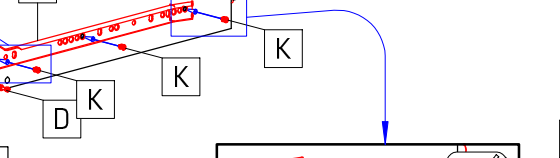
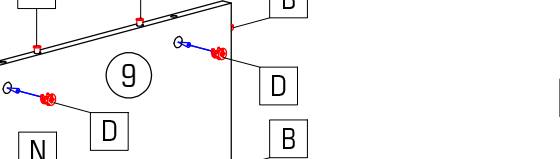
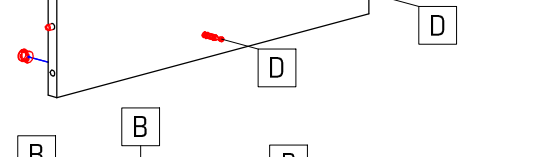
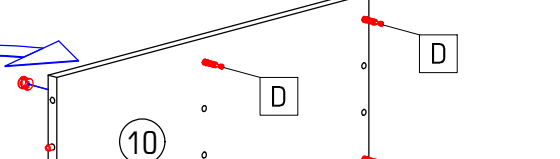
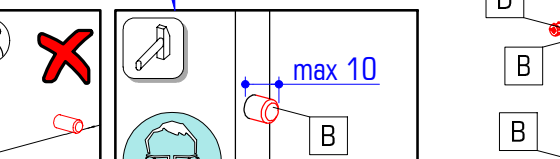
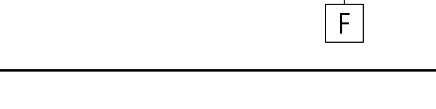
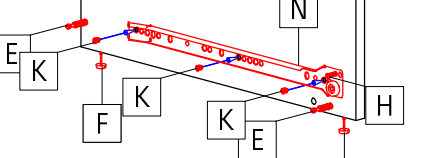
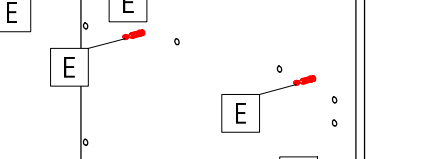
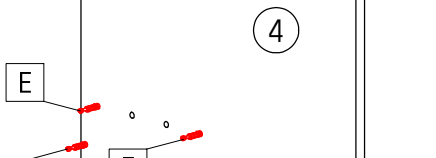
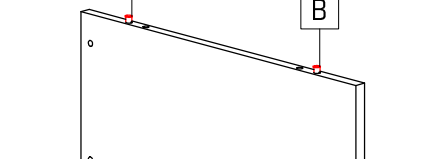
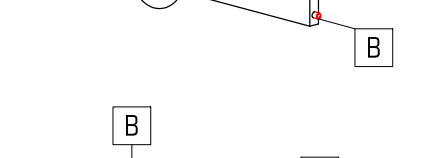
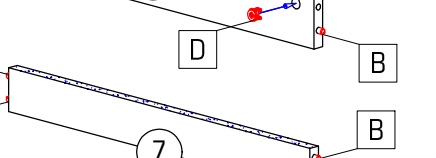
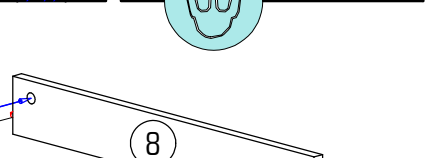
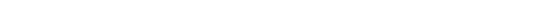
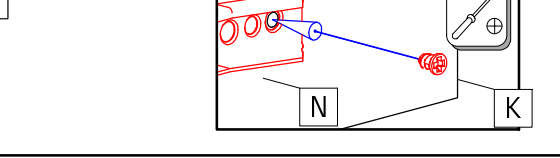
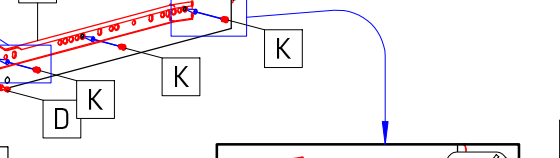
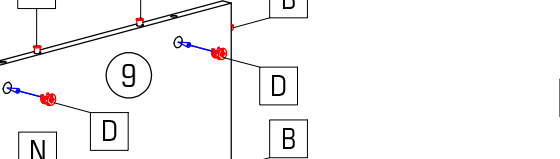
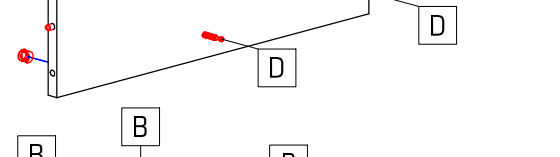
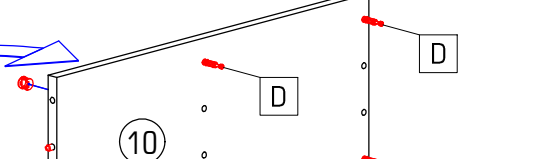
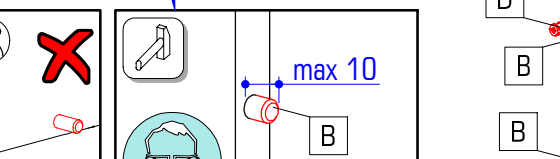
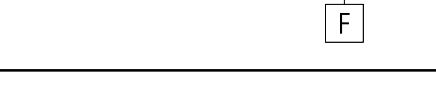
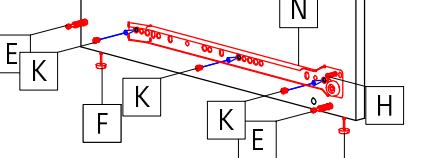
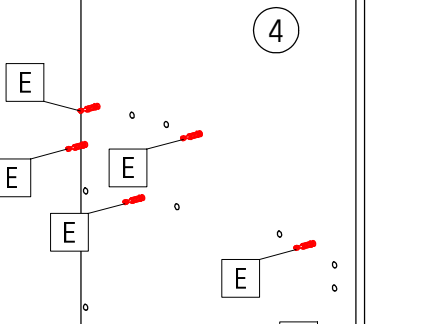
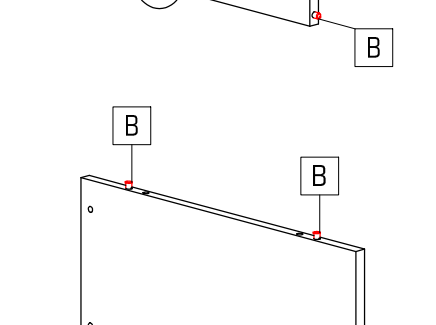
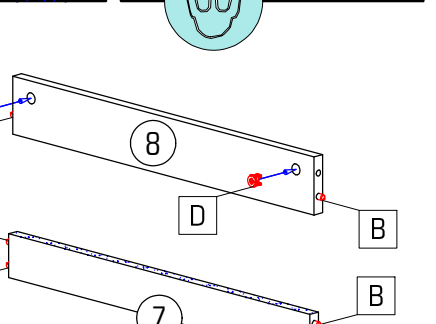
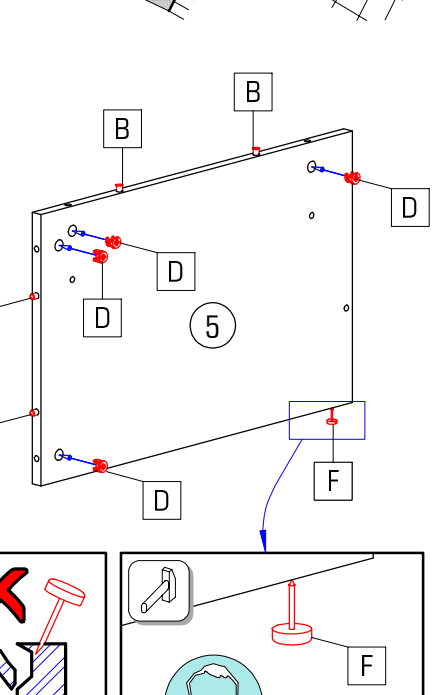
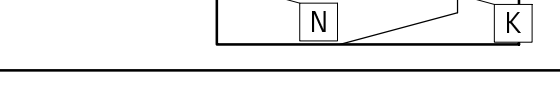
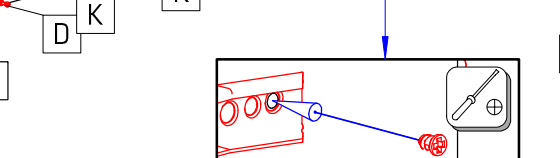
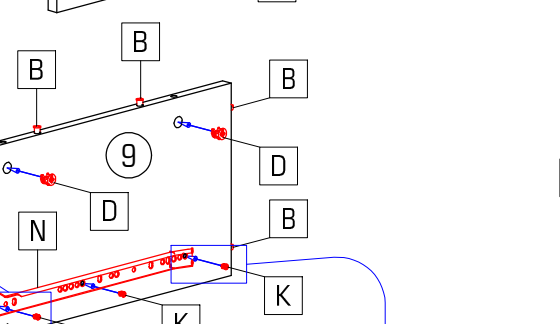
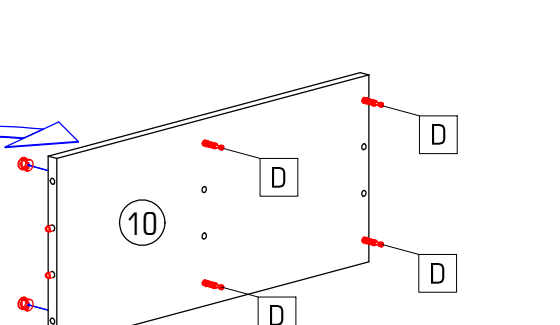
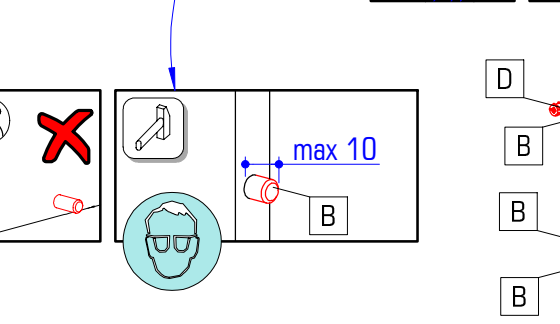
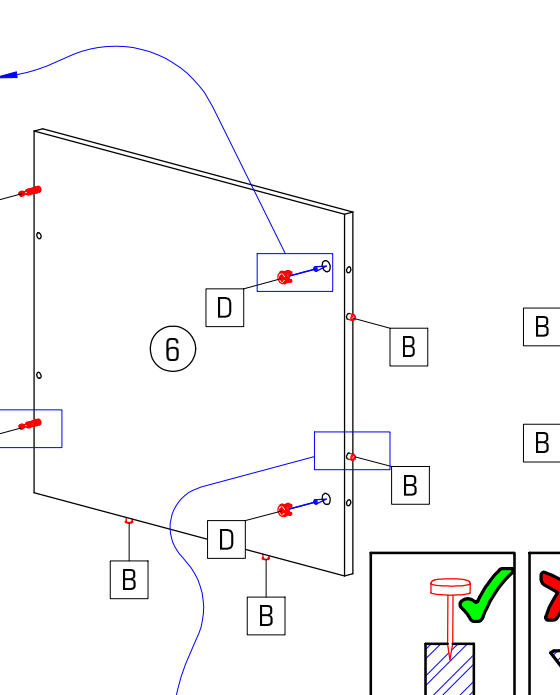
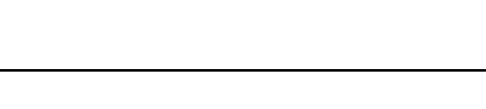
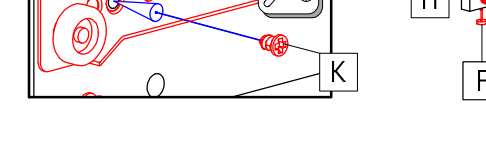
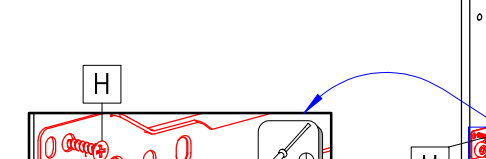
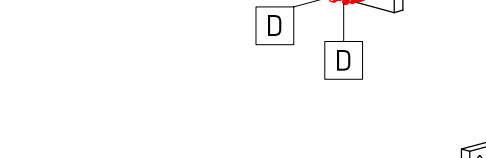
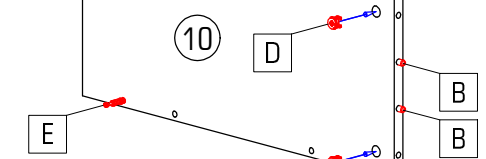
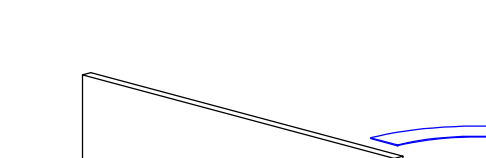
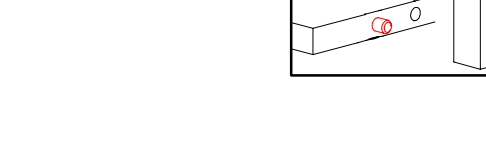
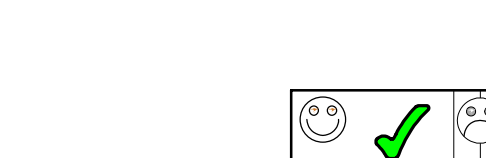
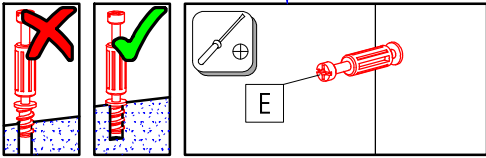
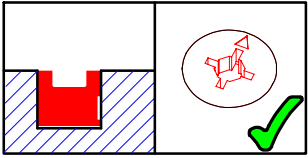
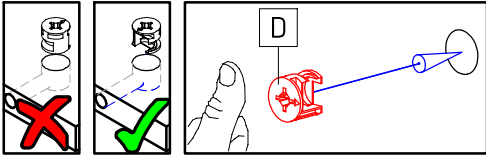
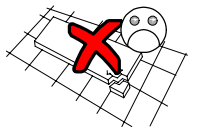
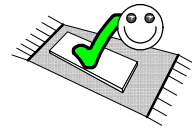

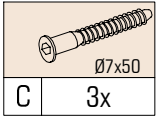

2x

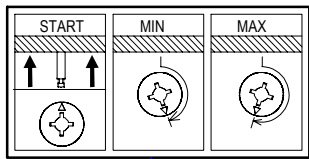
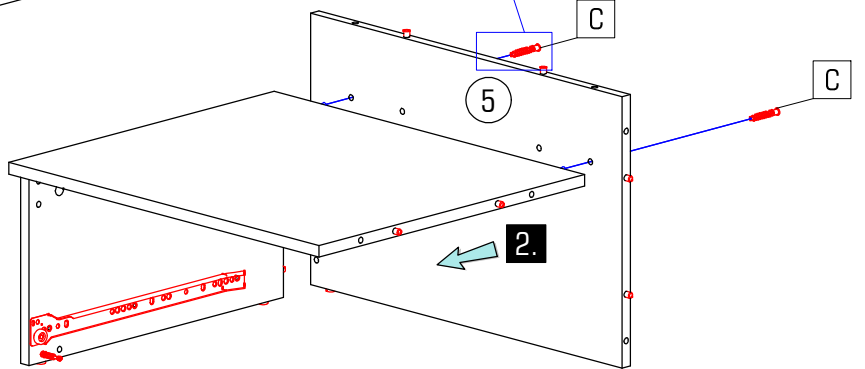
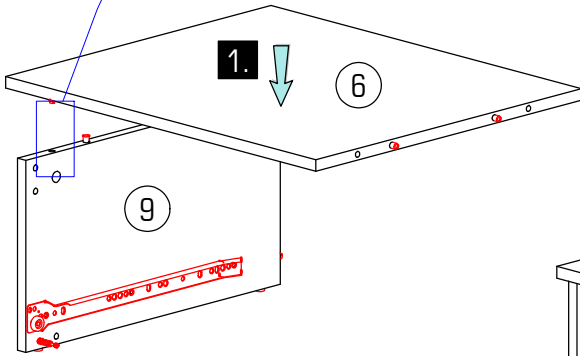
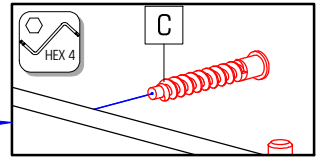
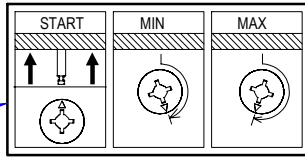

2x

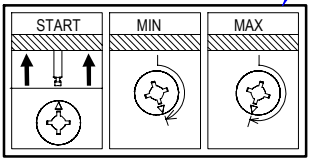
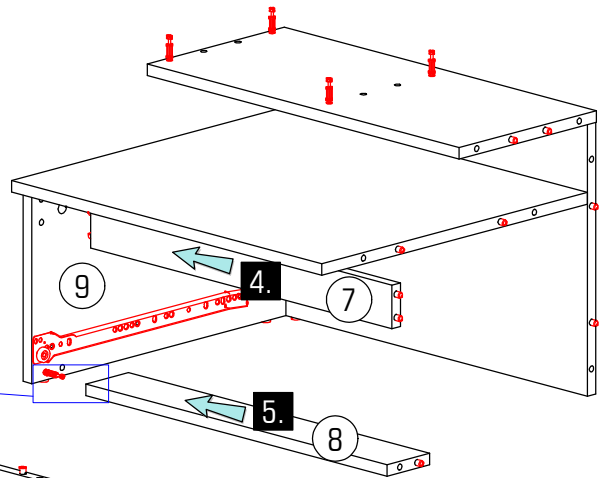
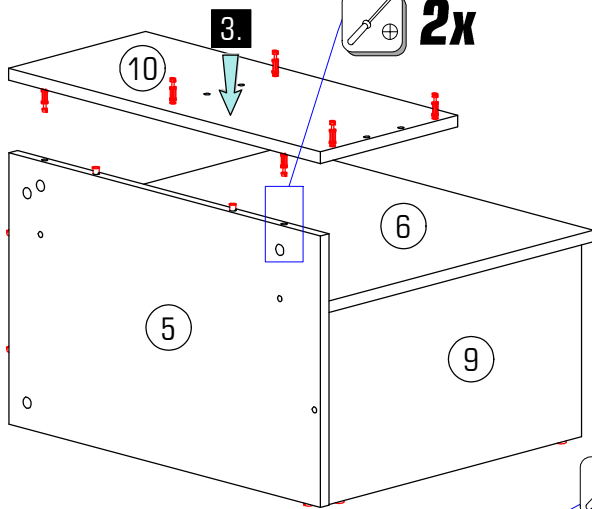



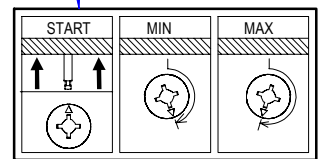
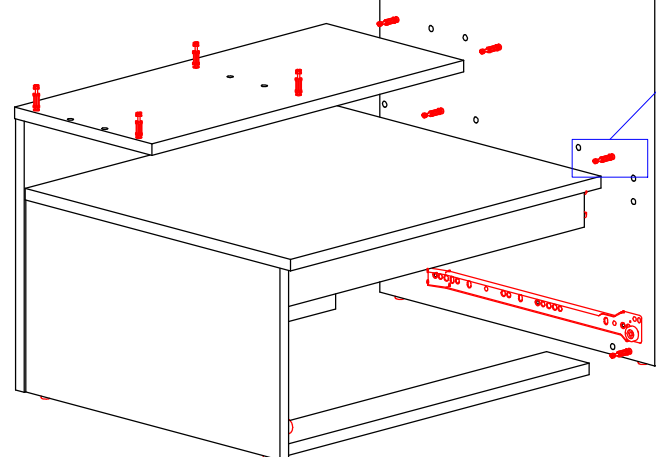

6.



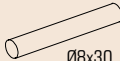

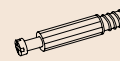
6.

4/8 NEREO NEW

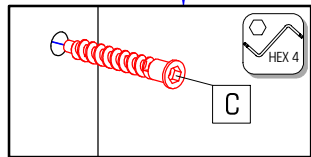
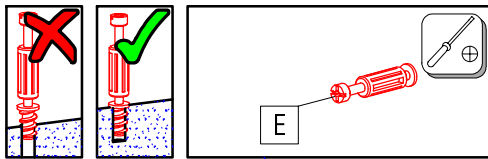
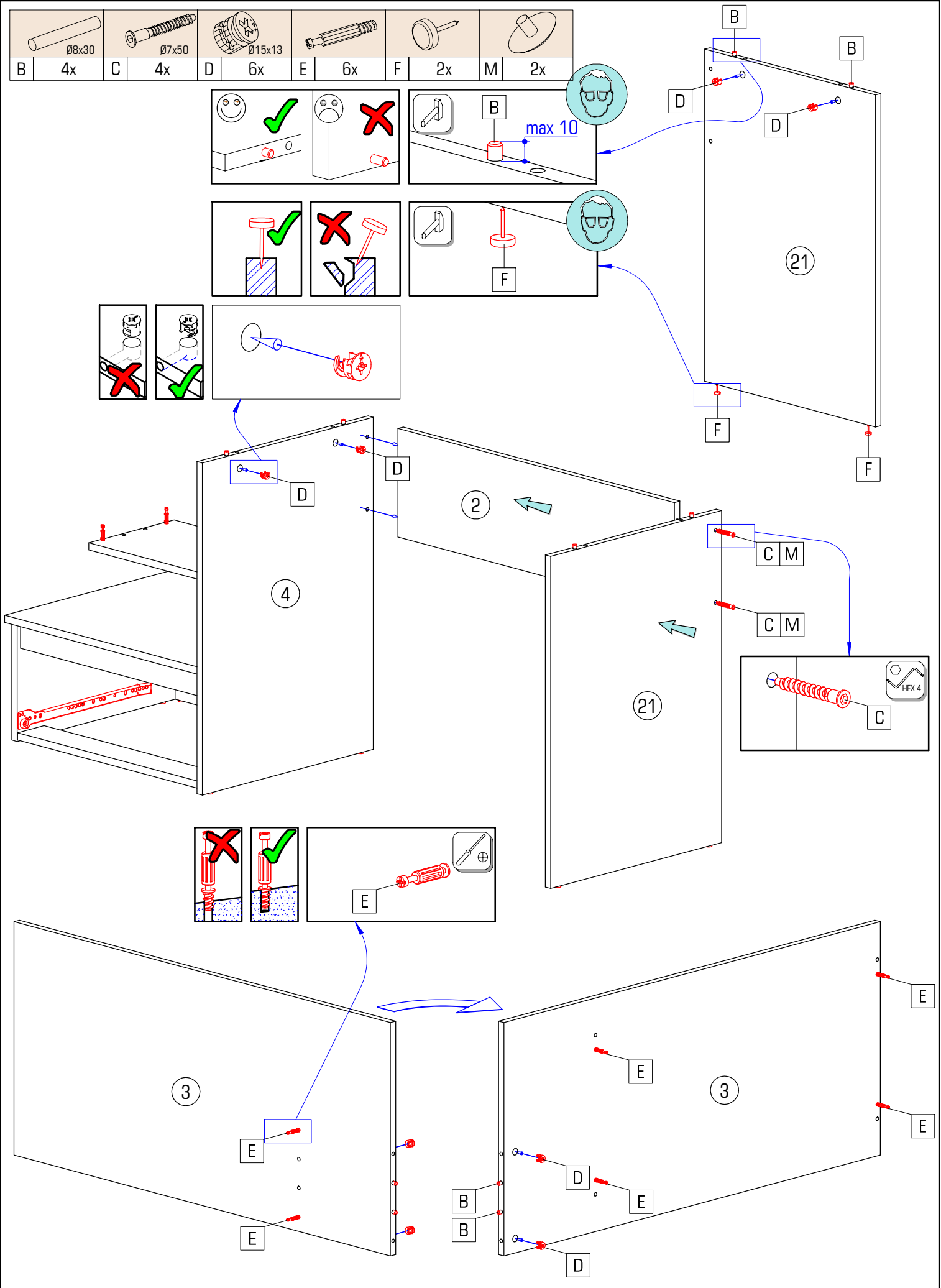
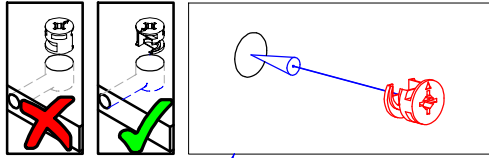
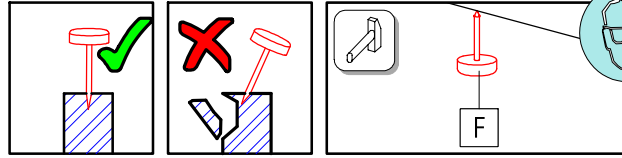
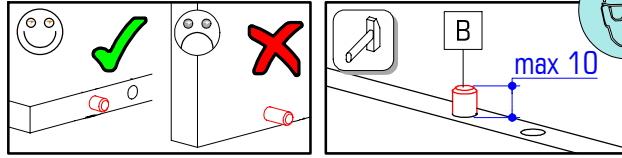
					
B 4x	C 4x	D 6x	E 6x	F 2x	M 2x



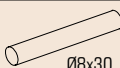

NEREO NEW 5/8

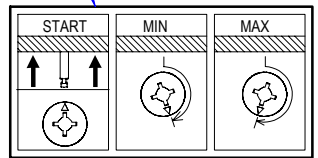
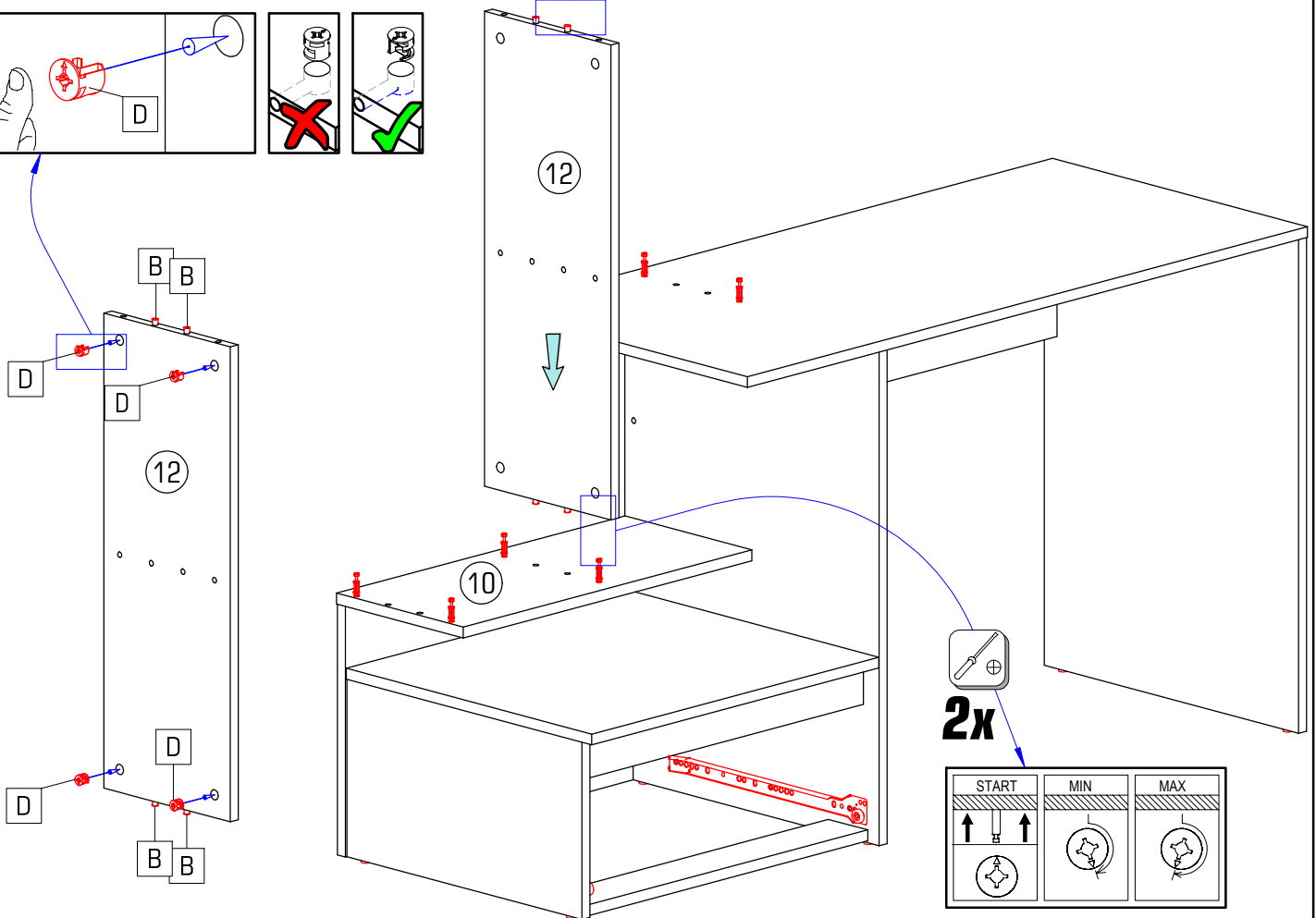
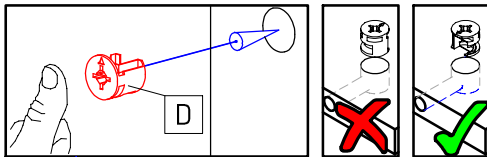
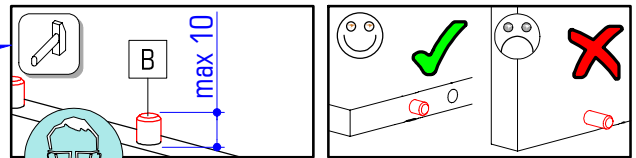
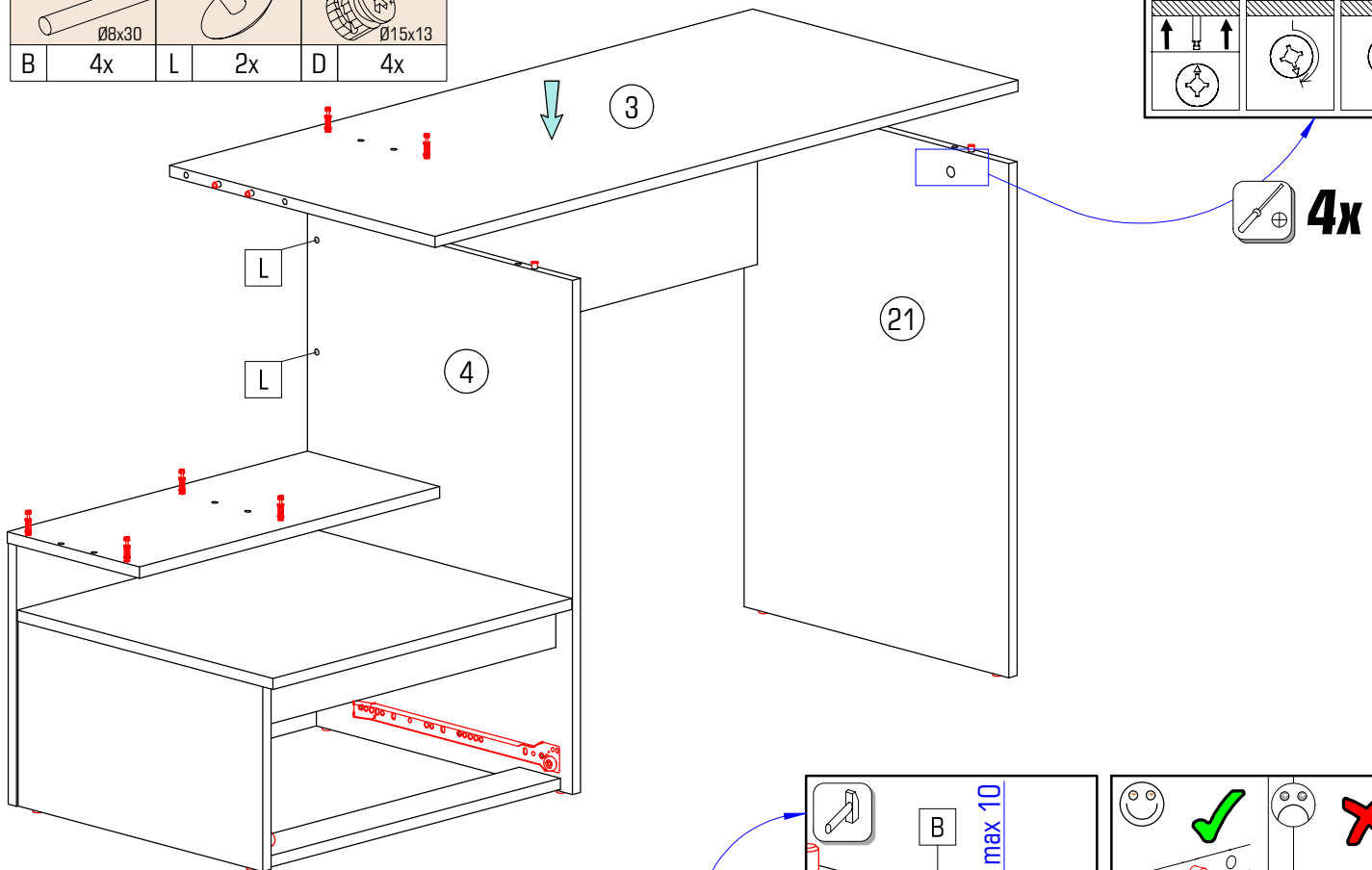
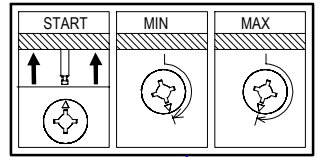
		
Ø8x30		Ø15x13
B 4x	L 2x	D 4x

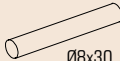

6/8 NEREO NEW

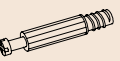
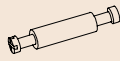

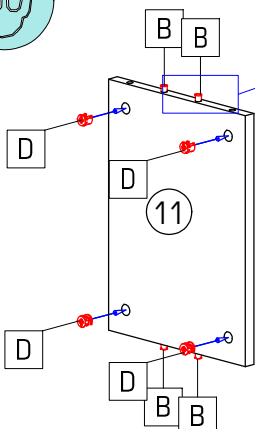
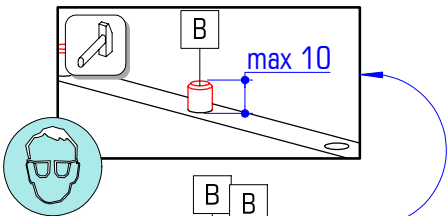
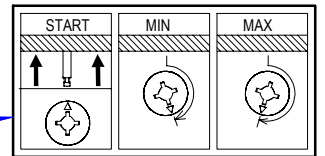
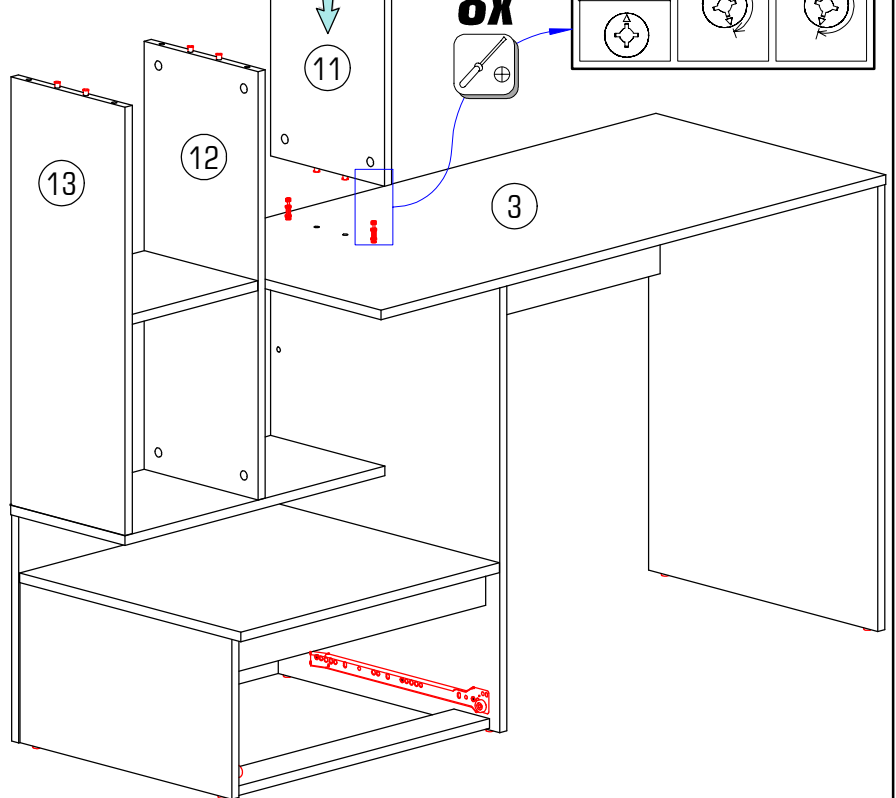
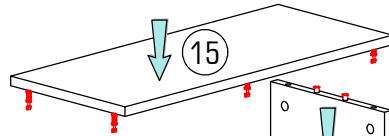
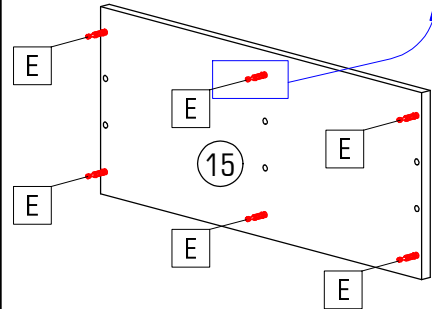
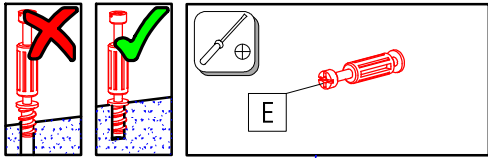
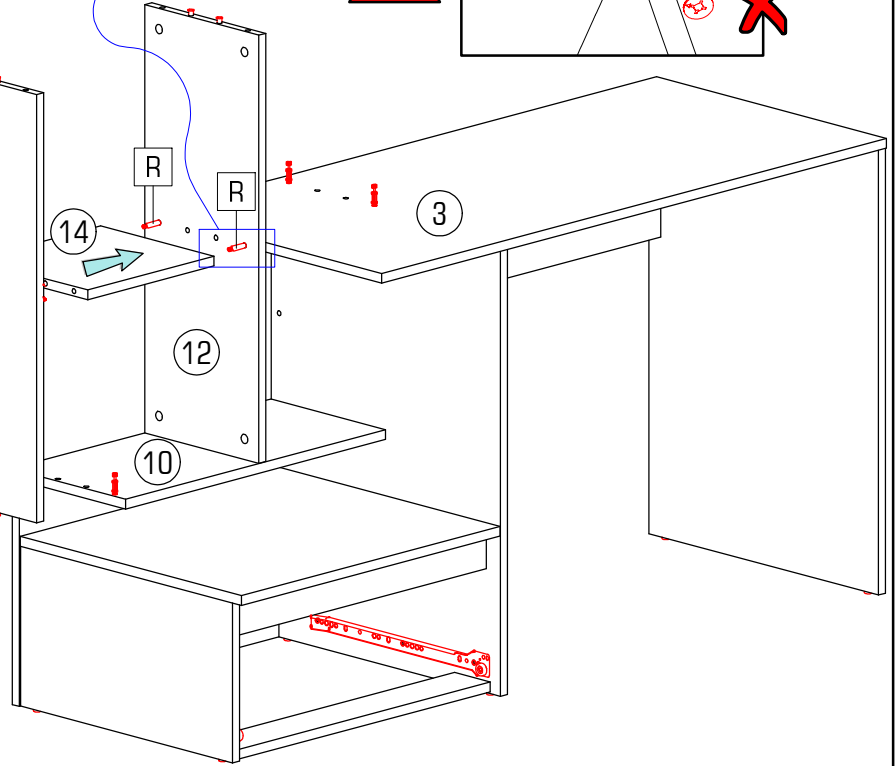
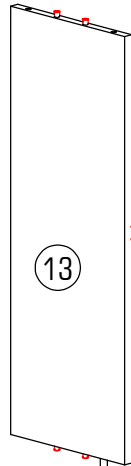
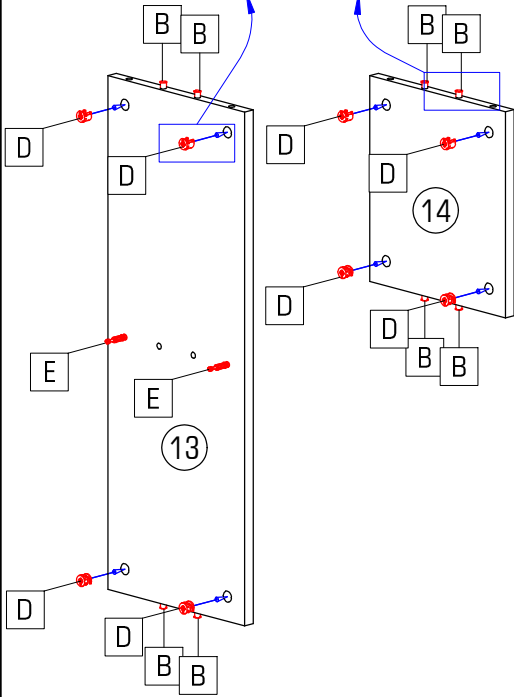
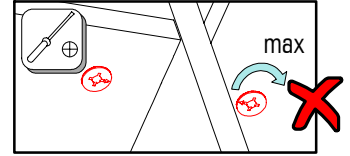
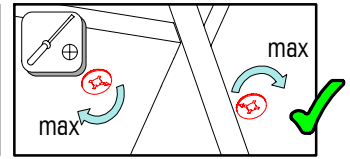
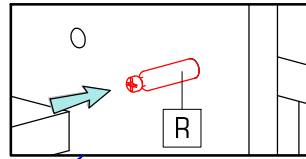
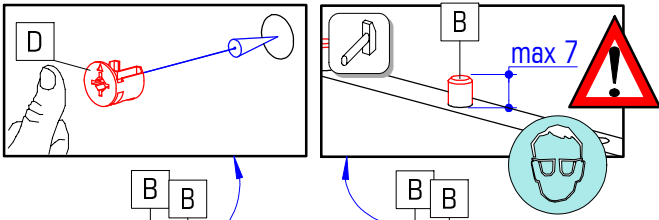
			
B 12x	D 12x	E 8x	R 2x

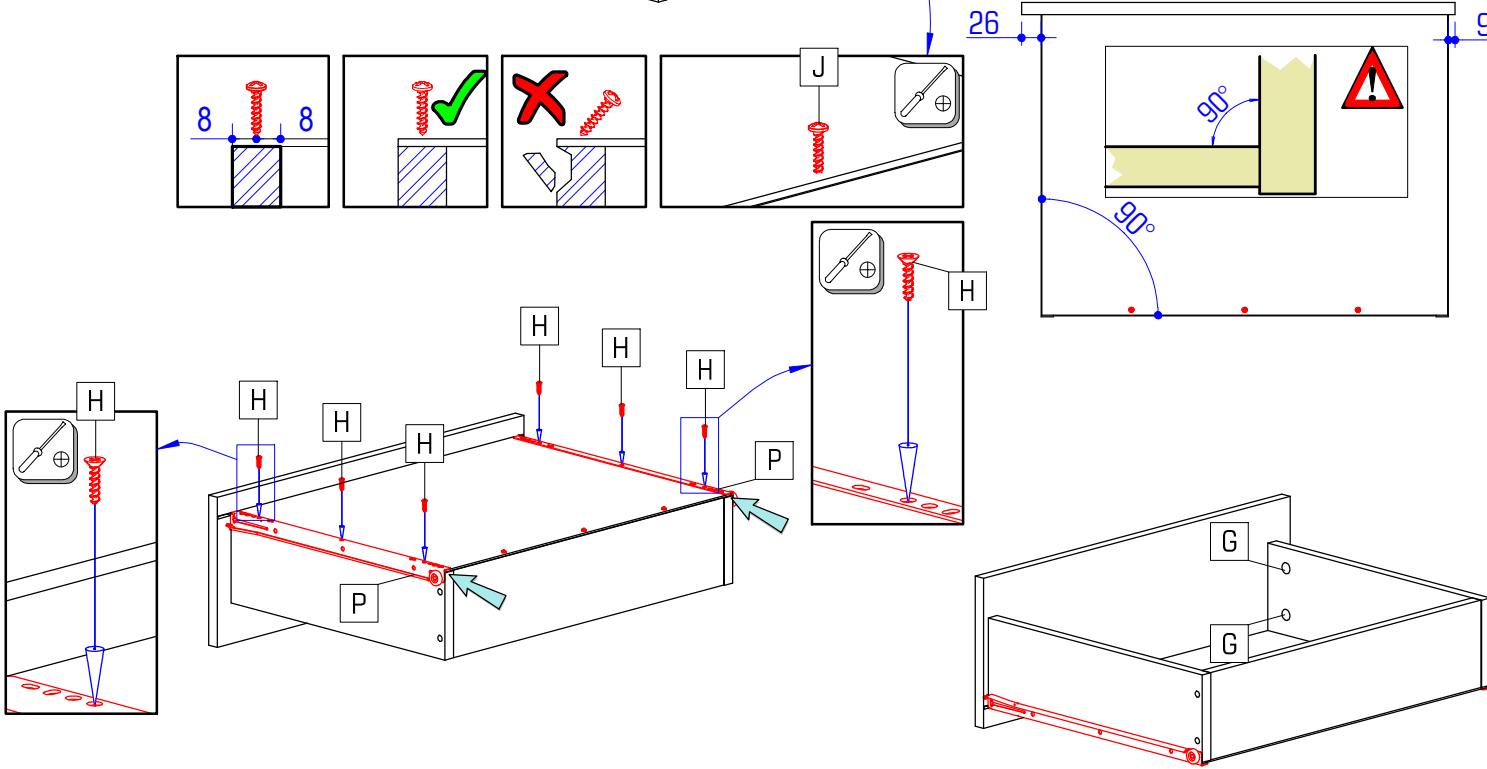
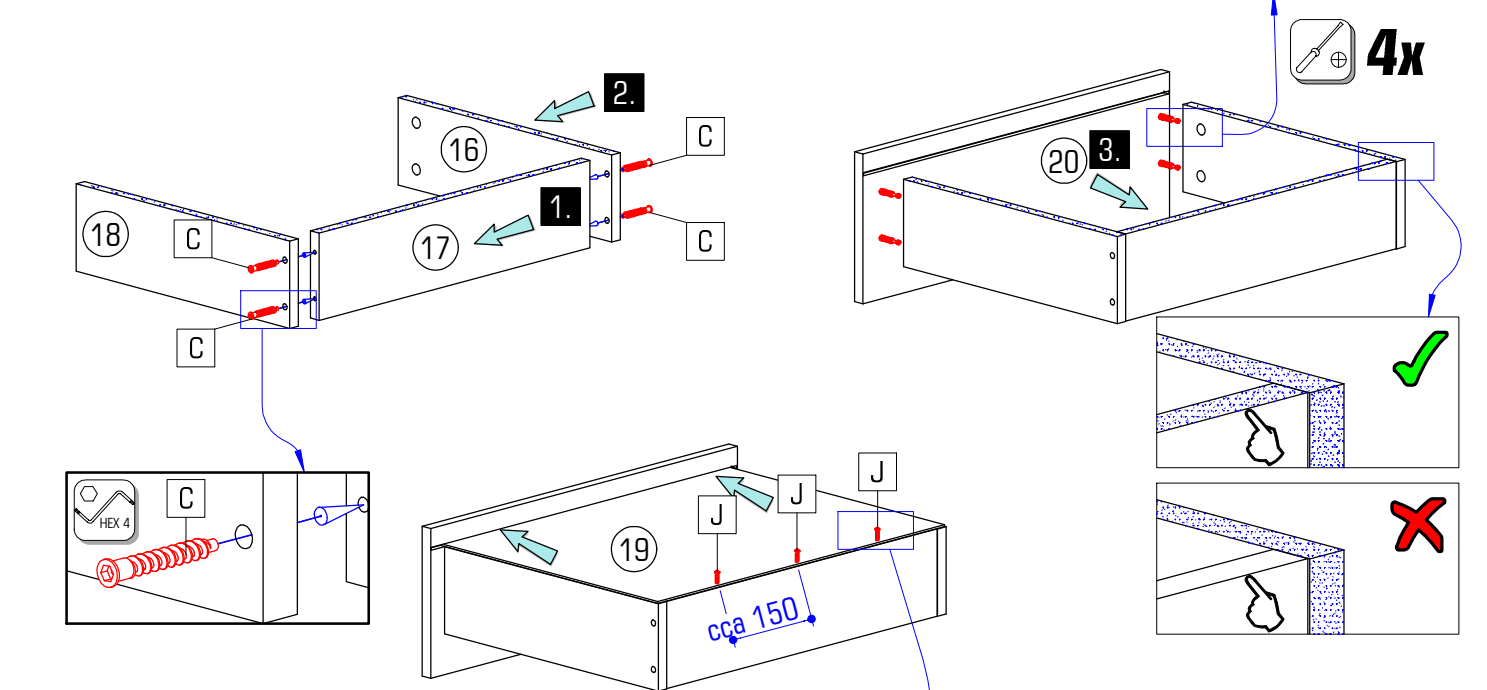
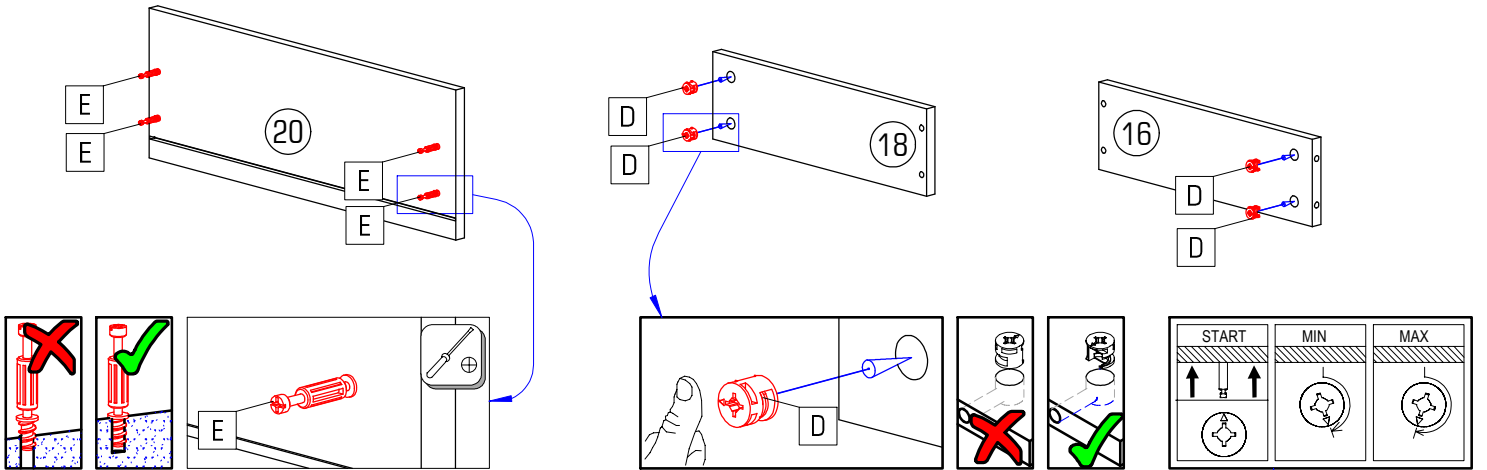

C 4x	D 4x	E 4x	G 4x	H 6x	J 3x
					P 1x



8/8 NEREO NEW

			
A	10x	G	12x

